

CYLINDER 2 LVS ADJUSTABLE SURFACE MOUNT

PROJECT NAME:	TYPE:
---------------	-------

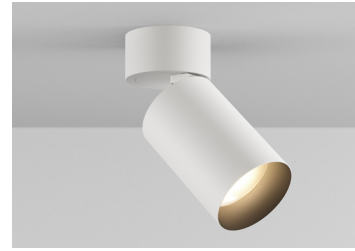

Highlight art, objects, places, spaces, seating areas, and architectural details with a classic profile that offers easy-to-adjust, in-field versatility.

ORDERING INFORMATION - CYLINDER

Quick Ship Product. All rough in components ship within 10 days up to quantities of 100.

CYLINDER	FIXTURE	RATING	CYLINDER FINISH	LUMEN PACKAGE	CCT	OPTIC	DRIVER	EFFECTS DEVICE	MOUNTING
CY2	3.13"	1					LVS		
	AD Standard 70° 9D Max 90° Tilt* AS Standard 70° Shallow Canopy* 9S Max 90° Tilt Shallow Canopy* AW Adjustable Wallwash 70°	1 Dry/Damp	WH White AG Satin Silver* AB Architectural Bronze* BK Black MA Machined Aluminum* CF Custom Finish*	STATICWHITE 80C12A 80+ CRI AD / 9D / AS / 9S Dlvd. Lumens - 775 AW Dlvd. Lumens - 557 80C19A 80+ CRI AD / 9D / AS / 9S Dlvd. Lumens - 1196 AW Dlvd. Lumens - 859 80C25A 80+ CRI AD / 9D / AS / 9S Dlvd. Lumens - 1587 AW Dlvd. Lumens - 1141 90C10A 90+ CRI AD / 9D / AS / 9S Dlvd. Lumens - 641 AW Dlvd. Lumens - 460 90C15A 90+ CRI AD / 9D / AS / 9S Dlvd. Lumens - 988 AW Dlvd. Lumens - 710 90C20A 90+ CRI AD / 9D / AS / 9S Dlvd. Lumens - 1312 AW Dlvd. Lumens - 943 97C09A 97+ CRI AD / 9D / AS / 9S Dlvd. Lumens - 584 AW Dlvd. Lumens - 420 97C14A 97+ CRI AD / 9D / AS / 9S Dlvd. Lumens - 901 AW Dlvd. Lumens - 648 97C19A 97+ CRI AD / 9D / AS / 9S Dlvd. Lumens - 1196 AW Dlvd. Lumens - 860	22 2200K* 27 2700K 30 3000K 35 3500K 40 4000K	10 10°* 15 15° 25 25° 40 40° 60 60° WW Wallwash* 25 25° 40 40° 60 60°	LVS Low Voltage System	STANDARD EFFECTS DEVICE 4 Soft Focus Lens N No Lens* W Wallwash Lens* ALTERNATE EFFECTS DEVICE 2 Honeycomb Louver* 3 Clear Glass Lens* 5 Frosted Glass Lens 6 Frosted Soft Focus Lens 7 Frosted Linear Spread Lens S Soft Focus Lens w/ Linear Spread Film C Clear Glass Lens w/ Linear Spread Film	ROUGH-IN JBMP 4" Sq. or 4/0 Junction Box Mounting Plate FINISH OUT SMK3 3/0 Surface Mount Kit SMK4 4/0 Surface Mount Kit CMJB 1/2" and 3/4" Conduit Ceiling Mount Junction Box*
				WARM DIM 90W11A 90+ CRI, Incandescent Profile AD / 9D / AS / 9S Dlvd. Lumens - 931 AW Dlvd. Lumens - 686 90W12A 90+ CRI, Standard Profile AD / 9D / AS / 9S Dlvd. Lumens - 1047 AW Dlvd. Lumens - 771 *SEE PAGE 3 FOR DETAILED WARM DIM PROFILE COMPARISON. *ALL DELIVERED LUMEN OUTPUTS REFLECT 3000K PAIRED WITH 60° / WW OPTIC AND STANDARD EFFECTS DEVICE.	WL 2700K - 1800K WD 3000K - 1800K	WW Wallwash* *Required and only available for AW fixture)			



PART NUMBER NOTES



- Adjustable ships as e.g., CY2-AD-1-WH-90C20A2-3-LVS-4
- Mounting ships separate from fixture, part numbers listed on page 7.

CYLINDER 2 LVS ADJUSTABLE SURFACE MOUNT

APPLICATION NOTES

- Lucifer Lighting will not supply a fixture with a POE node or power supply inside the fixture. This allows for easier site install with nodes of 2 or more outputs.
- Consult node manufacturer for maximum remote wiring distances.
- Fixture features 18 Gauge wiring.
- Wiring connections are made on the fixture using customer supplied connectors, ex. wire nuts, push-in connectors, or terminal blocks.
- Confirm node compatibility with factory if it is not listed.
- Customers are responsible for ensuring POE node drive current is set to correct values shown below.
- Customers must ensure voltage range of the proposed POE node encompasses the fixtures complete Vf range, both maximum and minimum. If assistance is required contact LLC rep or factory.

NODE COMPATIBILITY

Manufacturer	Model Number
 Igor® Enabling Smart Buildings™	NP50-60-C-F-5
 molex	180996-1001 180996-1002 180996-2001 180996-2002
 PLATFORMATICS	1 Channel Node, POE-LN2-1U-E 2 Channel Node, POE-LN2-2U-E 4 Channel Node, POE-LN2-4U-E

DRIVE CURRENT SPECIFICS

	80C			90C			97C			90W	
	12A	19A	25A	10A	15A	20A	09A	14A	19A	11A	12A
Minimum Vf	30.5	30.5	30.5	30.5	30.5	30.5	30.5	30.5	30.5	30.5	30.5
Maximum Vf	39	39	39	39	39	39	39	39	39	39	39
Current mA	250	400	550	250	400	550	250	400	550	400	400
Wattage W	8.2	13.6	19.4	8.2	13.6	19.4	8.2	13.6	19.4	13.6	13.6

	10 DEGREE OPTIC		
	80C12A	90C10A	97C10A
Minimum Vf	30.5	30.5	30.5
Maximum Vf	39	39	39
Current mA	400	400	400
Wattage W	13.6	13.6	13.6

WIRING DIAGRAM

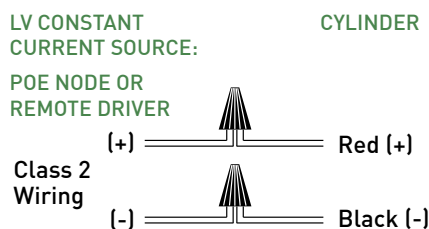
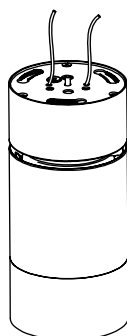

CYLINDER 2 LVS ADJUSTABLE SURFACE MOUNT

ACCESSORIES

ALTERNATE EFFECTS DEVICES

HCL-CY2-03 Honeycomb Louver *
*(Not available for Warm Dim)

CGL-CY2-03 Clear Glass Lens *
*(Not available for Warm Dim)

SFL-CY2-03 Soft Focus Lens

FGL-CY2-03 Frosted Glass Lens

FSFL-CY2-03 Frosted Soft Focus Lens

FLSL-CY2-03 Frosted Linear Spread Lens

SFL-LSL-CY2-03 Soft Focus Lens W/ Linear Spread Film

CGL-LSL-CY2-03 Clear Glass Lens W/ Linear Spread Film

REPLACEMENT OPTICS

Interchangeable optics accessible
by removing snoot or baffle.

RO-70-15-1 15° optic *
*(Not available for Warm Dim)

RO-70-25-1 25° optic

RO-70-40-1 40° optic

RO-70-60-1 60° optic

FIXED BODY REPLACEMENT SUCTION TOOL

Included with each CY2-FB order (1 per 10 fixtures).

CY-SQ-TOOL-SUCTION Baffle assembly removal tool

CYLINDER 2 LVS ADJUSTABLE SURFACE MOUNT

WALLWASH DESIGN GUIDE

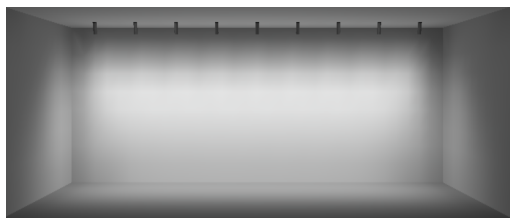

8FT CEILING

36" SETBACK / 36" ON CENTER SPACING / 15° TILT

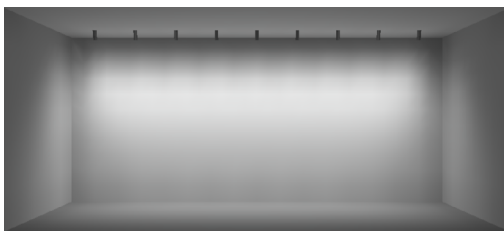

10FT CEILING

36" SETBACK / 36" ON CENTER SPACING / 15° TILT

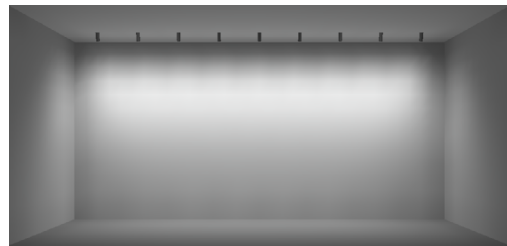

12FT CEILING

36" SETBACK / 36" ON CENTER SPACING / 15° TILT

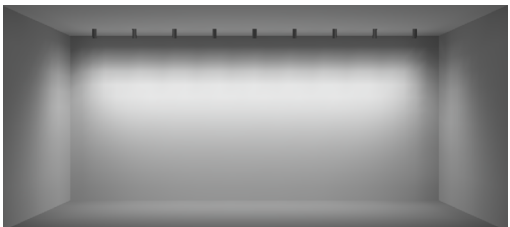

30" SETBACK / 30" ON CENTER SPACING / 10° TILT

- AVERAGE FC: 18.92
- MAX / MIN: 6.04
- 10FT CEILING SHOWN / 8-12FT IDEAL
- 9 FIXTURES / 25FT WALL SHOWN

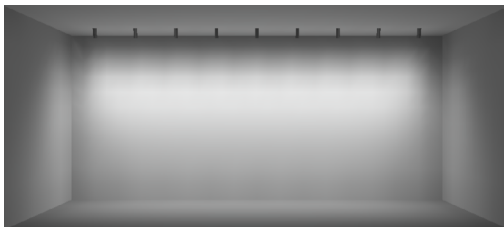

RECOMMENDED

36" SETBACK / 36" ON CENTER SPACING / 15° TILT

- AVERAGE FC: 17.19
- MAX / MIN: 4.90
- 10FT CEILING SHOWN / 8-12FT IDEAL
- 9 FIXTURES / 30FT WALL SHOWN

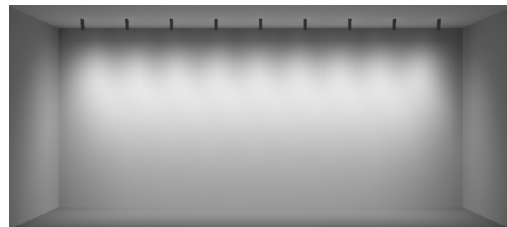

42" SETBACK / 42" ON CENTER SPACING / 20° TILT

- AVERAGE FC: 15.81
- MAX / MIN: 3.98
- 10FT CEILING SHOWN / 8-12FT IDEAL
- 9 FIXTURES / 35FT WALL SHOWN

ADDITIONAL SETBACKS AND SPACINGS

ON CENTER SPACING	SETBACK / TILT		
	30" / 10° TILT	36" / 15° TILT	42" / 20° TILT
30"	SHOWN ABOVE	AVERAGE FC: 20.07 MAX / MIN: 5.33	AVERAGE FC: 18.50 MAX / MIN: 6.02
36"	AVERAGE FC: 16.14 MAX / MIN: 5.60	SHOWN ABOVE	AVERAGE FC: 18.13 MAX / MIN: 4.24
42"	AVERAGE FC: 14.07 MAX / MIN: 5.45	AVERAGE FC: 14.94 MAX / MIN: 4.50	SHOWN ABOVE

***ALL DATA REFLECTS 90C15A LUMEN PACKAGE**

CYLINDER 2 LVS ADJUSTABLE SURFACE MOUNT

STATIC WHITE PERFORMANCE - 3000K

LUMEN PACKAGE	WATTAGE	10° OPTIC NO SOFT FOCUS LENS		15° OPTIC SOFT FOCUS LENS		25° OPTIC SOFT FOCUS LENS		40° OPTIC SOFT FOCUS LENS		60° OPTIC SOFT FOCUS LENS		WW OPTIC WALLWASH LENS	
		DELIVERED	LPW	DELIVERED	LPW	DELIVERED	LPW	DELIVERED	LPW	DELIVERED	LPW	DELIVERED	LPW
80C12A	10	1000	58 (17W)	872	87	739	73	727	73	775	78	557	56
80C19A	17	-	-	1345	80	1139	67	1121	67	1196	71	859	51
80C25A	24	-	-	1786	75	1513	63	1488	62	1587	67	1141	48
90C10A	10	848	49 (17W)	721	72	611	61	601	60	641	64	460	46
90C15A	17	-	-	1112	66	942	55	926	55	988	59	710	42
90C20A	24	-	-	1476	62	1251	52	1230	52	1312	55	943	40
97C09A	10	703	41 (17W)	657	66	557	55	548	55	584	58	420	42
97C14A	17	-	-	1014	61	859	50	845	50	901	54	648	39
97C19A	24	-	-	1346	56	1140	47	1121	47	1196	50	860	36
90W11A	16	-	-	-	-	901	56	766	47	931	58	686	42
90W12A	16	-	-	-	-	1013	63	861	53	1047	64	771	48

OUTPUT MULTIPLIER	
CCT	CCT SCALE
2200K	0.800
2700K	0.957
3000K	1.000
3500K	1.019
4000K	1.030

LIGHT LOSS FACTOR MULTIPLIER	
No Lens	1.05
SFL	1.00
CGL	1.00
FGL	0.90
FSFL	0.87
FLSL	0.83
SFL W/ LINEAR SPREAD	0.82
CGL W/ LINEAR SPREAD	0.82
HCL	0.65

WARM DIM PERFORMANCE - SOFT FOCUS LENS - 60° OPTIC

STANDARD WARM DIM PROFILE

90W12A 3000K - 1800K	Full on 100%	Dimmed to 80%	Dimmed to 70%	Dimmed to 50%	Dimmed to 20%	Dimmed to 10%	Dimmed to 2%
CCT (K)	3000	2950	2920	2775	2375	2000	1800
Light Output (Lm)	1047	837	732	523	209	104	20
Power (W)	14	11	10	7	3	1.5	0.3
Efficacy (LPW)	64	64	64	64	64	64	64

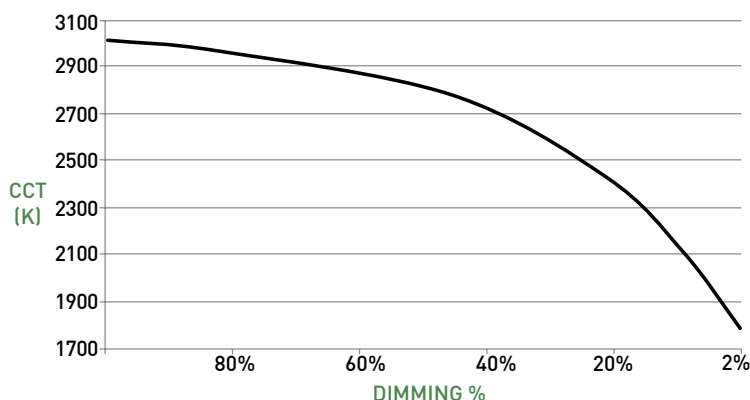

WARM DIM TO MIRROR INCANDESCENT DIMMING PROFILE

90W11A 2700K - 1800K	Full on 100%	Dimmed to 80%	Dimmed to 70%	Dimmed to 50%	Dimmed to 20%	Dimmed to 10%	Dimmed to 2%
CCT (K)	2700	2650	2620	2520	2180	1950	1800
Light Output (Lm)	931	744	651	465	186	93	18
Power (W)	16	13	11	8	3	1.7	0.3
Efficacy (LPW)	58	58	58	58	58	58	58

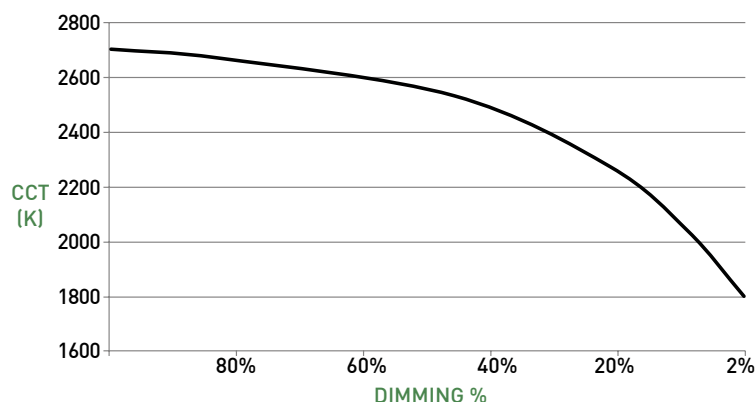

CYLINDER 2 LVS ADJUSTABLE SURFACE MOUNT

CYLINDER ASSEMBLY

- A LUMINAIRE**
Body with integrated heat sink and LED. Conceals hidden twist-on mounting hardware. Power supply must be remote mount.
- B STANDARD CANOPY**
Die-cast canopy accommodates flat and slope ceiling conditions. Conceals hidden twist-on mounting hardware. "AD" (70° tilt, 357° rotation) and "9D" (90° tilt, 357° rotation) canopy features 1.60" (41mm) tall canopy. Available with integral or remote driver.
- C SHALLOW CANOPY**
Die-cast canopy accommodates flat and slope ceiling conditions. Conceals hidden twist-on mounting hardware. "AS" (70° tilt, 357° rotation) and "9S" (90° tilt, 357° rotation) canopy features 0.50" (13mm) tall canopy, reducing overall height. Requires remote power supply.
- D STANDARD OPTICS**
Proprietary optics available in 10°, 15°, 20°, 40° & 60° beams.
- WALLWASH OPTIC**
Precision tuned optic provides uniform wallwashing effect.
- E EFFECTS DEVICE**
Fixture body and accepts 1 lens; soft focus lens, no lens or wallwash lens standard. Sealed in place for Wet locations.
- F BAFFLE**
Threaded removable cowling provides virtually seamless joint with fixture body.

DIMENSIONS / DRAWINGS

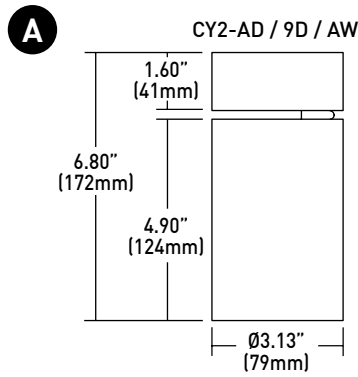

STANDARD CANOPY

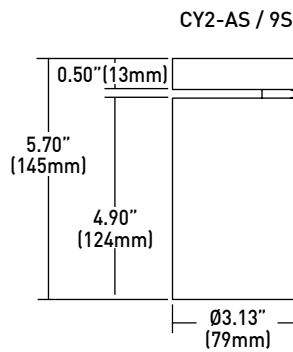
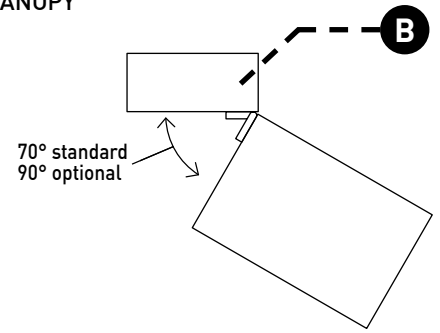

SHALLOW CANOPY

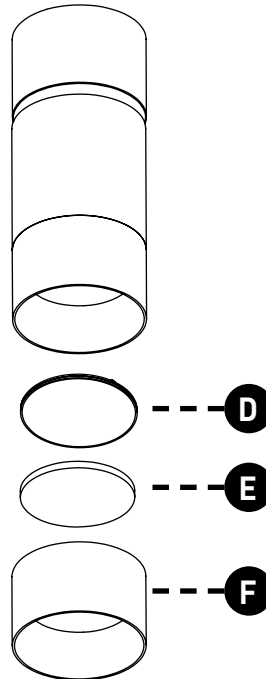
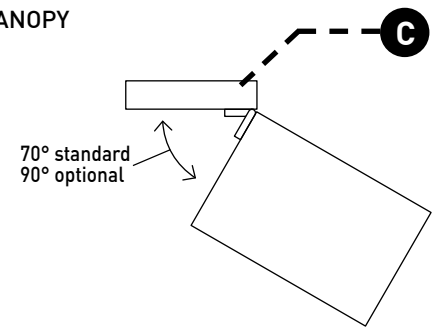

CYLINDER 2 LVS ADJUSTABLE SURFACE MOUNT

MOUNTING

- G JBMP**
Mounting plate (concealed) for standard 4" square or 4" 4/0 j-box . To be installed during rough-in prior to substrate. Fixture to mount flush with minimalist transition to ceiling.
Part Number - CY2/3-JBMP
- H SMK3**
Surface mount kit includes mounting plate and 4" concealer plate that installs between fixture and standard 3" 3/0 j-box for existing applications where standard j-box cutout is to be concealed.
Part Number - CY2/3-SMK-3/0-(FINISH)
- I SMK4**
Surface mount kit includes mounting plate and 5" concealer plate that installs between fixture and standard 4" 4/0 j-box for existing applications where standard j-box cutout is to be concealed.
Part Number - CY2/3-SMK-4/0-(FINISH)
- J CMJB**
Ceiling mount junction box perfectly matches the cylinder profile for a continuous, integrated look where exposed ceiling mount junction box and conduit applications apply. For use with 1/2" and 3/4" EMT conduit only. Features two conduit entrances on either side and one conduit knockout on top of j-box. J-box is IP10 rated; painted finishes only. Blank off plugs included.
Part Number - CY2-CMJB-(FINISH)

DIMENSIONS / DRAWINGS

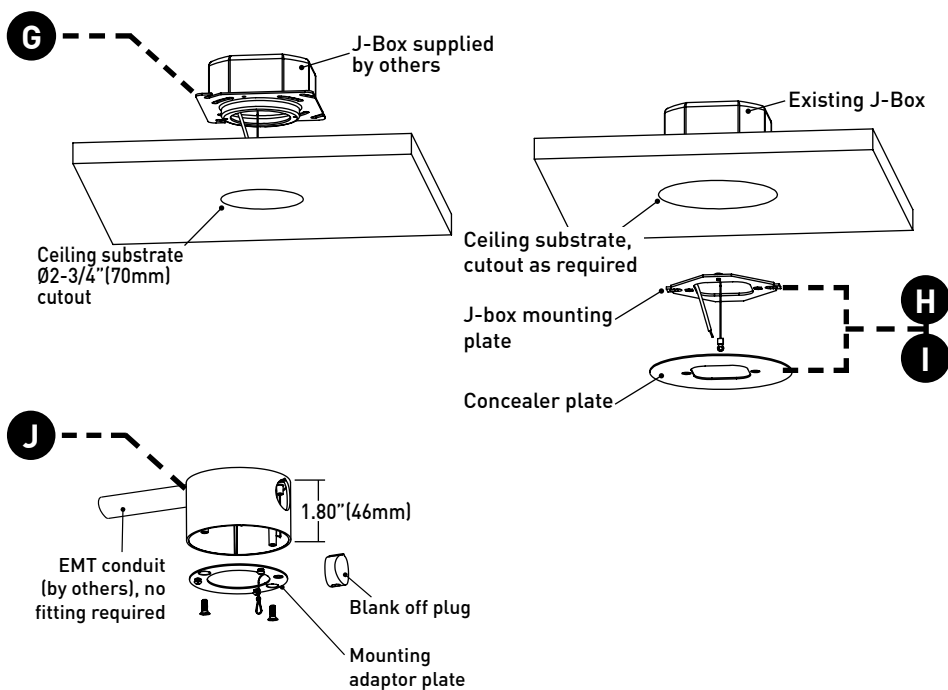

MOUNTING NOTES

- CY2/3-JBMP and CY2/3-SMK-3/0 & 4/0 not recommended for use with pancake style j-box.
- Fixtures are surface mount and must have access to free air. For applications involving slat ceilings or confined mounting, consult Comprehensive Install Guide for required clearances for proper air flow and servicing.

CYLINDER 2 LVS ADJUSTABLE SURFACE MOUNT

TECHNICAL

CONSTRUCTION

Cylinder: Die-cast aluminum body; extruded aluminum internal heat-sink; painted finishes are granulated powder coat.

CMJB: Die-cast aluminum body; painted finishes are granulated powder coat.

STATIC WHITE LED

2-step MacAdam ellipse LED module available in 80+, 90+ and 97+ CRI configurations in color temperatures of 2200K, 2700K, 3000K, 3500K and 4000K. Average rated lamp life of 50,000 hours. LED and driver assemblies are field-replaceable.

WARM DIM LED

3-step MacAdam ellipse warm dim LED module available in 90+ CRI configuration. 3000K or 2700K at full brightness, warming to 1800K at full dim. Average rated lamp life of 50,000 hours. LED and driver assemblies are field-replaceable.

WALLWASH SPACING AND TILT

Cylinder must be tilted to achieve wallwashing effect. Recommended fixture spacing is 36" (914mm) on center with 36" (914mm) setback from wall plane with 30° tilt.

MOUNTING

Cylinder is supplied with a mounting adaptor plate, which integrates with required additional mounting accessories specified separately according to field application conditions, providing a minimalist transition from standard 4/0 or 4" square junction boxes and accommodating ceiling thicknesses of 0.44" (12mm) to 0.75" (19mm). Ceiling-mount junction box available for 1/2" (13mm) and 3/4" (19mm) conduit and feature concealed internal clamps for clean fitting-free conduit exit and entry.

LISTING

cTUVus listed to UL2108 standard for Dry / Damp locations.

WEIGHT

Cylinder / Mounting - 2.4 lbs

LIMITED WARRANTY

Manufacturer's 1-year warranty guarantees product(s) listed to be free from defects in material and workmanship under normal use and service. 5-year warranty on LED to operate with 70% of the original flux and remain within a range of 3 duv. Warranty period begins from the date of shipment by Seller. [Consult website for full warranty terms and conditions.](#)

CHANGE LOG

- 01/12/2021: ADDED 2200K, 2700K-1800K WARM DIM AND 10 DEGREE OPTIC OFFERINGS.
- 11/17/2021: UPDATE 25° PHOTOMETRICS.
- 06/21/2022: ADDED SOFT FOCUS LENS W/ LINEAR SPREAD FILM, AND CLEAR GLASS LENS W/ LINEAR SPREAD FILM.